

产品说明 Product Description:

1.表面处理 Surface treatment :

电镀Sn , Tin plating

2.外观 Appearance:

>30CM距离, <5S目视, 无腐蚀、刮伤、氧化

No corrosion, scratches, oxidation on surface

Inspection condition:

Inspect from >30cm away and for <5 seconds

3.环保: 符合ROHS&REACH

RoHS&REACH compliance: Yes

REV. (版本)	DESCRIPTION (修改内容)	DATE. (日期)

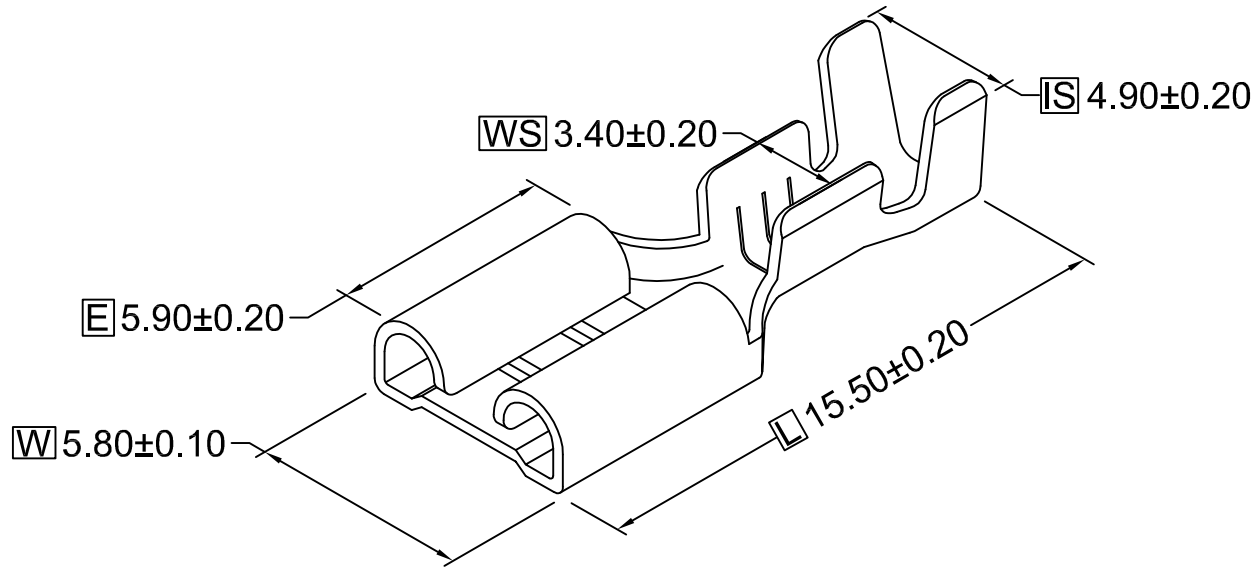
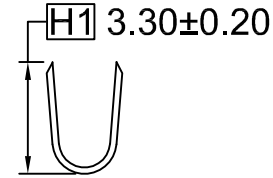
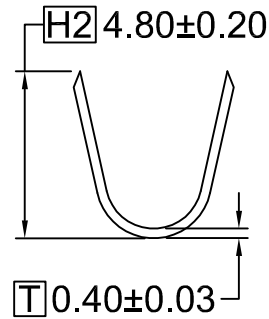

所下载之产品规格表
仅供参考用
The products of download is only for reference

未标注尺寸公差参考 Unmarked dimensional tolerance reference		导线导体规格 Conductor	16~20AWG	
0±0.2	0°±5°	导线绝缘OD Insulation	-	
0.0±0.2	0.0°±3°	核准 APPROVED	尺寸单位 Units	mm
0.00±0.1	0.00°±1°	审核 CHECKED	日期 DATE	版本 REV.
0.000±0.05		制图 DRAWING		

产品料号 Part NO.	B187082BS2	文件名称 File Name	规格图 Product Specification
产品规格 Note	-	文件编号 File NO.	-
客户料号 Customer's Part NO.	-	单重 Single Weight	-
材质 Material	黄铜Brass(C2680)	包装数量 Packing Q' TY	10000Pcs/Reel
适配端子 Mating Part/ Spec.	(W)4.8*(T)0.5mm	认证编号 Certification NO.	E207921

