

产品说明 Product Description:

1.检查项目 Check Item:

1、尺寸量测及规格确认。(量测部位以标英文字母为主)

Dimension measurements: To measure the specifications marked with alphabets

2、外观：无压痕、气泡、缩水、变形、缺胶穿孔；颜色无杂质无异色等。

Appearance: no indentation, bubbles, deformation, short of glues, strange colour, and impurities

2.符合ROHS或客户环保要求

Comply with RoHS or customers's eco-friendly requirements

3.备注 NOTE:

REV. (版本)	DESCRIPTION (修改内容)	DATE. (日期)

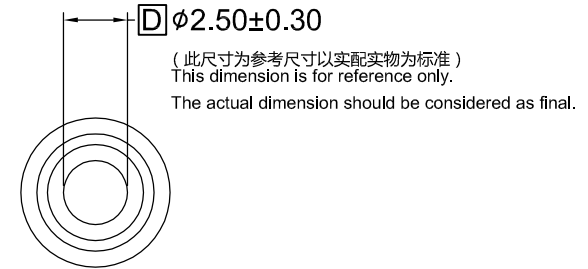
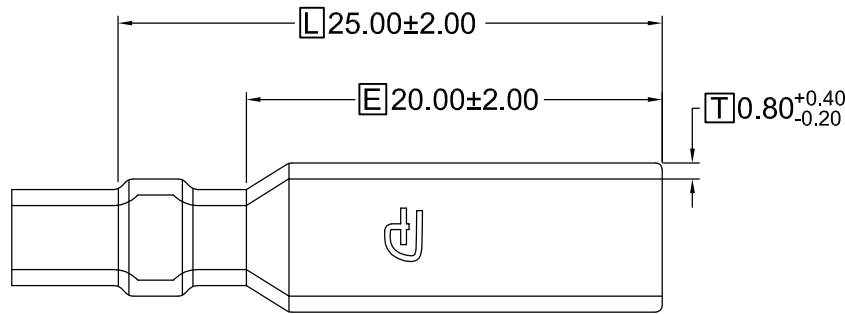
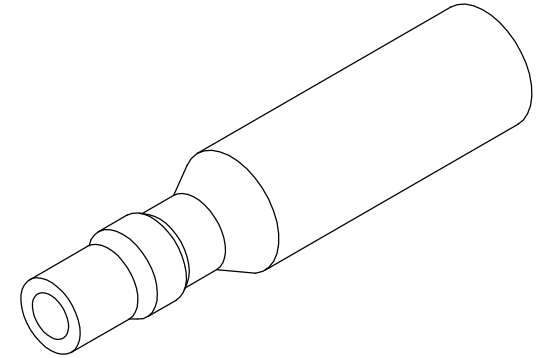

所下载之产品规格表
仅供参考用
The products of download is only for reference

未标注尺寸公差参考 Unmarked dimensional tolerance reference		颜色 Colour	透明(Transparent)	
0±0.2	0°±5°	防火等级 Flammability rating	UL94V-2	
0.0±0.2	0.0°±3°		尺寸单位 Units	mm
0.00±0.1	0.00°±1°		日期 DATE	版本 REV.
0.000±0.05		核准 APPROVED	审核 CHECKED	制图 DRAWING

产品料号 Part NO.	J22125	文件名称 File Name	规格图 Product Specification
产品规格 Note	-	文件编号 File NO.	-
客户料号 Customer's Part NO.	-	单重 Single Weight	-
材质 Material	PVC	包装数量 Packing Q' TY	2000/Bag
适配端子 Mating Part/ Spec.	G350052B5 G396062B5	认证编号 Certification NO.	-

