

产品说明 Product Description:

1.外观 Appearance:

>30CM距离, <5S目视, 无腐蚀、刮伤、氧化
No corrosion, scratches, oxidation on surface

Inspection condition:

Inspect from >30cm away and for <5 seconds

2.环保: 符合ROHS&REACH

RoHS&REACH compliance: Yes

REV. (版本)	DESCRIPTION (修改内容)	DATE. (日期)

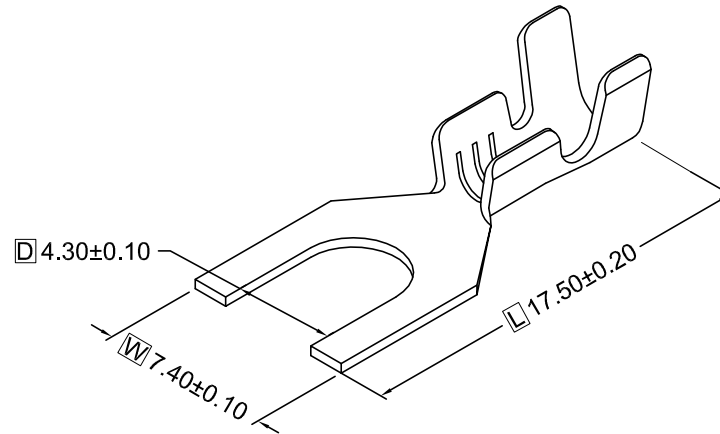
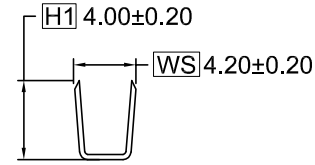
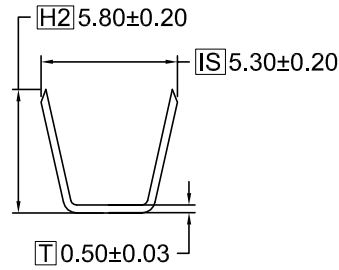

所下载之产品规格表
仅供参考用
The products of download is only for reference

未标注尺寸公差参考 Unmarked dimensional tolerance reference		电线导体规格 Conductor	14~16AWG	
0±0.2	0°±5°	电线绝缘OD Insulation	-	
0.0±0.2	0.0°±3°	核准 APPROVED	尺寸单位 Units	mm
0.00±0.1	0.00°±1°	审核 CHECKED	日期 DATE	版本 REV.
0.000±0.05		制图 DRAWING		

产品料号 Part NO.	R431263	文件名称 File Name	规格图 Product Specification
产品规格 Note	-	文件编号 File NO.	-
客户料号 Customer's Part NO.	-	单重 Single Weight	-
材质 Material	-	包装数量 Packing Q' TY	5000Pcs/Reel
适配端子 Mating Part/ Spec.	-	认证编号 Certification NO.	-

